



USE AND CARE GUIDE

SAVE THESE INSTRUCTIONS FOR FUTURE REFERENCE

IMPORTANT!
To get the best performance from
your dryer, read all operating
instructions before using it for the
first time.

T741C

CONTENTS

| | |
|-----------------------------------|----|
| IMPORTANT SAFETY INSTRUCTIONS | 2 |
| SAFETY FEATURES | 2 |
| ASKO DRYER FEATURES | 3 |
| ENERGY SAVING TIPS | 3 |
| INSTALLATION INSTRUCTIONS | 4 |
| PREPARING THE LAUNDRY | 9 |
| T741C OPERATING INSTRUCTIONS | 11 |
| CARE AND MAINTENANCE INSTRUCTIONS | 14 |
| TROUBLESHOOTING | 16 |
| PRODUCT WARRANTY | 17 |
| INDEX | 18 |

IMPORTANT SAFETY INSTRUCTIONS

WARNING!

To reduce the risk of fire, electric shock, or injury to persons when using your appliance, follow basic precautions, including the following:

- ◆ Read all instructions before using the appliance.
- ◆ Do not wash or dry articles that have been previously cleaned in, washed in, soaked in, or spotted with gasoline, dry-cleaning solvents, cooking oils, other flammable or explosive substances as they give off vapors that could ignite or explode.
- ◆ Do not allow children to play on or in the appliance. Children should be closely supervised when near the appliance.
- ◆ Before the appliance is removed from service or discarded, remove the door to the drying compartment.
- ◆ Do not reach into the appliance if the drum is moving.
- ◆ Do not install or store this appliance where it will be exposed to the weather.
- ◆ Do not tamper with controls.
- ◆ Do not attempt to repair or replace any part of the appliance or perform any servicing unless specifically recommended in this guide.
- ◆ Do not use fabric softeners or dryer sheets unless the manufacturer gives written assurance that the product will not damage a tumble dryer.
- ◆ Do not heat-dry items containing:
 - vinyl, plastic, foam rubber or similarly textured rubberlike materials
 - fiberglass
 - wool unless the label specifies “washable”
- ◆ Clean the lint filter before or after each load.
- ◆ Keep the area around the exhaust opening and adjacent surrounding areas free from the accumulation of lint, dust and dirt.
- ◆ The interior of the machine should be cleaned periodically by an authorized ASKO service agent.
- ◆ Do not place items exposed to cooking oils in your dryer. Items contaminated with cooking oils may contribute to a chemical reaction that could cause a load to catch fire.
- ◆ Electrical installation, if required, must be done by a licensed electrician.
- ◆ Do not operate appliance while away from the home.

- ◆ Do not heat dry items that have been dry-cleaned.
- ◆ The dryer is made and marked to facilitate recycling. When it is no longer useful, contact your local refuse collection service for advice on how to properly dispose of the dryer for purposes of recycling.

WARNING!

This appliance must be properly grounded.

GROUNDING INSTRUCTIONS

A) Grounding instructions for a grounded, cord-connected appliance

In the event of malfunction or breakdown, grounding will reduce the risk of electric shock by providing a path of least resistance for electric current. This appliance (Canadian market only) is equipped with a cord having an equipment-grounding conductor and a grounding plug. The plug must be plugged into an appropriate outlet that is properly installed and grounded in accordance with all local codes and ordinances.

To reduce the risk of fire, this appliance must be exhausted outdoors or the equivalent. Do not exhaust into a chimney, wall, ceiling or concealed space in a building.

WARNING!

Improper connection of the equipment-grounding conductor can result in a risk of electric shock. Check with a qualified electrician or service representative or personnel if you are in doubt as to whether the appliance is properly grounded.

Do not modify the plug provided with the appliance (Canadian market only).

If it will not fit the outlet, have a proper outlet installed by a qualified electrician.

B) Grounding instructions for a permanently connected appliance:

This appliance must be connected to a grounded metal, permanent wiring system, or an equipment-grounding terminal or lead on the appliance.

NOTE: This manual does not cover every possible condition and situation that may occur. Use common sense and caution when installing, operating, and maintaining any appliance.

SAFETY FEATURES

CHILD-SAFE DOOR CATCH

ASKO dryers have a child-safe magnetic door catch that allows the door to be easily opened from the inside.

CHILD-SAFE START FEATURE

You can program Model T741C not to start unless the Start button is held down for three seconds. This is to prevent children from inadvertently starting the machine. Refer to the operating instructions for the model to program this safety feature.

AUTOMATIC DOOR SWITCH

A door switch automatically stops the dryer when the door is opened. The dryer will not start again until you close the door and press the Start button.

OVERHEAT PROTECTION

ASKO dryers have an overheat protection switch that automatically turns off the machine if the temperature gets too high. Refer to page 3 for more information.

ASKO DRYER FEATURES

Your new energy-efficient ASKO dryer is designed to give you maximum drying performance using less energy. To make the most of the dryer's functions and features, we recommend that you read this manual carefully before using your machine for the first time. For operating instructions, refer to the section in this guide for your specific model.

Below is an illustration of the parts and features of your ASKO dryer.

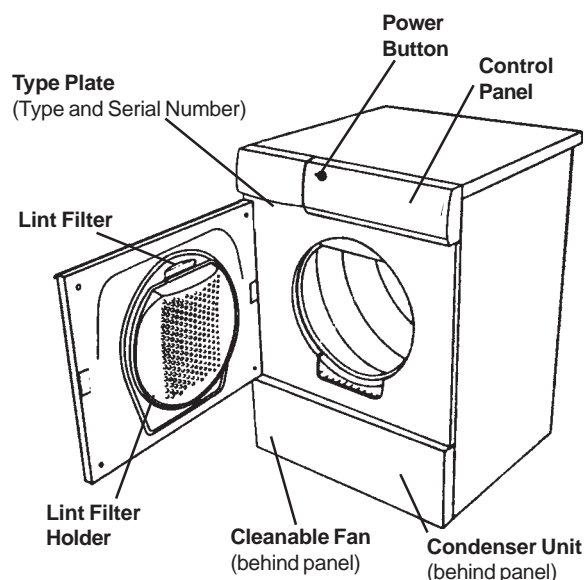

DRYING SYSTEM

Sensidry™

Model T741, have our state-of-the-art Sensidry system. The machine is equipped with a humidity sensor that ensures different fabrics always dry thoroughly. This sensor turns off the heat when the laundry has reached the appropriate dryness.

OVERHEAT PROTECTION

ASKO dryers are designed with an overheat protection switch that will automatically turn the machine off if the temperature gets too high. The machine will not start until it has cooled down sufficiently.

If the unit shuts down because of overheating, check that the lint filter, vent duct, and the condenser unit are free of lint. These components need to be cleaned on a regular basis. Additionally, the lint filter may need to be cleaned with warm, soapy water and a soft brush a few times a year to ensure the filter screen is not blocked. Using dryer sheets (not recommended) can also cause this problem.

Should the machine turn itself off because of overheating, it will not be possible to restart the unit until it has cooled down sufficiently. This could possibly take up to thirty minutes.

To restart the unit once it has cooled down, press the "Start" button.

NOTE: If your dryer overheats frequently, it may not be vented properly or the room in which it is located may not have sufficient air circulation. Contact your installer to have these issues checked out.

COOL-DOWN

Every program on an ASKO dryer ends with a cool-down cycle to reduce wrinkling. See page 13.

ENERGY SAVING TIPS

- ◆ Dry consecutive loads to avoid reheating the dryer.
- ◆ Do not overload the dryer.
- ◆ Use the highest spin speeds allowed for the garments.
- ◆ Do not put extremely wet clothes into the dryer.
- ◆ Dry like fabrics together (i.e., heavy fabrics together, light fabrics together).
- ◆ Clean the lint filter after each load.
- ◆ Do not over-dry clothes when using the timed program.
- ◆ Spin the clothes at no less than 800 rpm.

INSTALLATION INSTRUCTIONS

Read these instructions carefully and completely before you install the machine. The installation should be carried out by a qualified person who is familiar with all local codes and ordinances for electrical and plumbing connections.

NOTE: Cosmetic damage must be reported to your dealer within five days from the date of purchase. After unpacking the dryer, thoroughly check the unit for cosmetic damage.

SPECIFICATIONS

Height 33-1/2"–34-1/2 (850–876 mm)
Width 23-7/16" (595 mm)
Depth 24-7/16" (620 mm)
Weight 86 lbs (39 kg)
Drum material Stainless Steel
Outer casing Stove-enamelled hot-dipped galvanized steel

Power requirement 2800 watts
For connection Single-phase, 230 V, 30 Amp
Heating element 2500 watts

CONDENSATION DRAIN CONNECTION

Install the dryer so the condensed water will continuously flow into a drain or sink. To do this, follow the instructions below:

1. Disconnect the short hose (1) from the blue connection. (It's okay to let the hose hang down.)
2. Connect the rubber hose supplied with the dryer to the blue nipple (2).
3. Run the hose to a drain or sink, as illustrated.

NOTE: The drain hose must not be more than 40" above the floor.

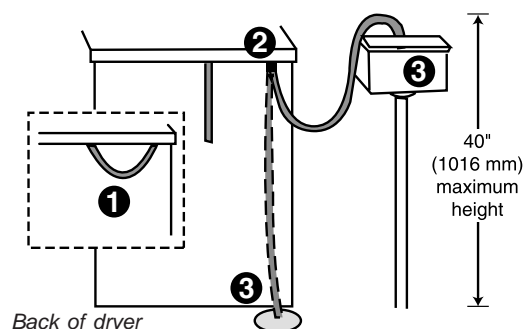

LEVELING THE MACHINE

It is important that the machine is level. Each foot on the dryer is adjustable, so you can level the unit on any surface. Once it is level, securely tighten the lock nuts on the feet.

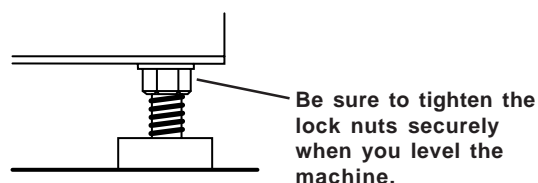

FREESTANDING INSTALLATION

The dryer can be placed next to the washing machine. It is essential that the machine is leveled and the locknuts are tight to eliminate vibration noise.

There should be at least 1/2" (12 mm) of space between the washer and dryer.

BUILT-IN INSTALLATION

ASKO dryers can be installed beneath a cabinet or worktop with a minimum height of 34" (864 mm). There must be a gap of about 1/2" (12 mm) all around the machine, including between the rear edge of the machine top panel and the back wall. The opening width must be at least 24-1/2" (622 mm).

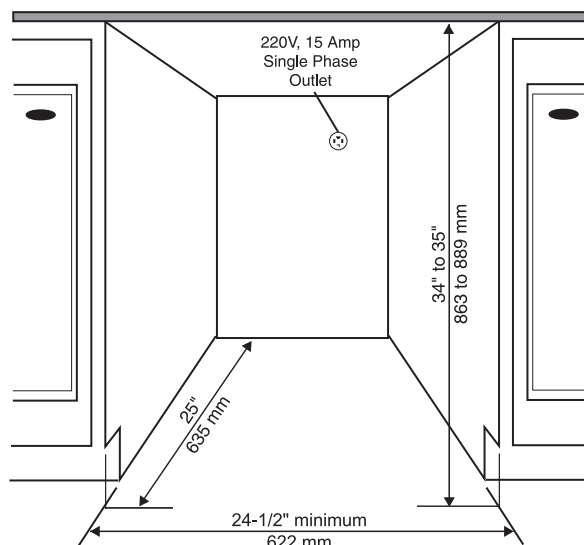

NOTES: The height adjustment for the dryer is 33-1/2" to 34-1/2" (850 mm to 876 mm). Do not raise it higher than 34-1/2".

CONDENSING DRYERS

The condensing models work best when they have good air circulation. Therefore, we don't recommend they be installed beneath a cabinet. If it is necessary, however, be sure to leave a gap of at least 1/2" (12 mm) on all sides.

Install the dryer so the condensed water will continuously flow into a drain or sink, you will need a drain outlet behind the unit. The maximum drain height is 40" (1016 mm). (See page 4.)

ELECTRICAL CONNECTIONS

WARNING!

This appliance must be properly grounded. Refer to the "Important Safety Instructions" on page 2 for grounding instructions.

The power supply cord must be grounded. If the machine is to be used in a wet area, the supply must be protected by a residual current device.

Connection to a permanently wired supply point must be made only by a qualified electrician.

As supplied: Single-phase, 230 V, 60 Hz,
2500 Watt heater rating
30 A fuse required

WARNING:

The receptacle on the rear of the machine is designed to accommodate ASKO washers ONLY (rated 208–240 V.) To use this receptacle, you must use the ready-fitted plug supplied with the washing machine or an equivalent.

ASKO washers rated 208–240 V have two internal fuses of 15 A each.

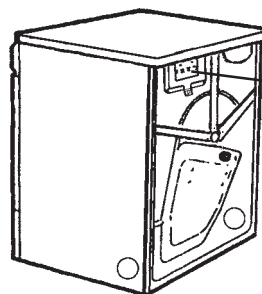

Remove cover to access terminal box. (Requires a 20-Torx screwdriver.)

NOTE: In Canada, the dryer is delivered ready-fitted with a four-prong plug intended for connection to a single-phase supply.

CONNECTING A 3-WIRE POWER CORD

WARNING!

Before starting this procedure, be sure the power is turned off at the breaker/fuse box.

Power Supply Cord

You will need a 3-wire power supply cord with three No. 10 copper wires and a matching 3-wire receptacle of NEMA Type 10-30R, as illustrated below:

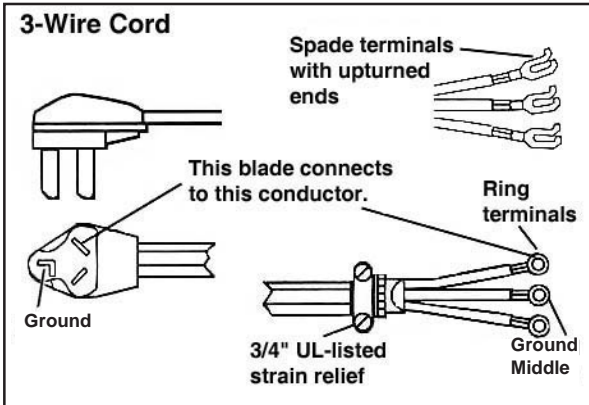

To connect a 3-wire power cord to the dryer, follow the steps below.

NOTE: The numbers in the illustration below correlate to the step numbers.

1. Turn the power off at the breaker/fuse box.
2. Remove terminal block cover.
3. Use the strain relief attached below the terminal block opening.
4. Loosen or remove center terminal block screw.
5. Connect ground (middle) wire of power supply cord to the center, silver-colored terminal screw. Tighten screw.
6. Connect the other wires to outer screws.
7. Tighten the strain relief screws.
8. Replace terminal box cover on back of dryer.
9. Plug dryer into wall receptacle.
10. Turn power on at breaker/fuse box.

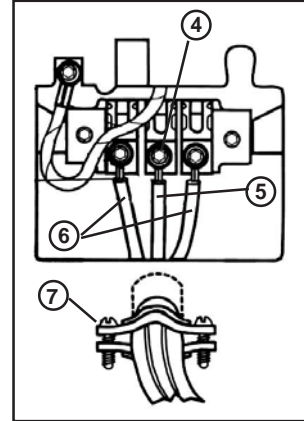

CONNECTING A 4-WIRE POWER CORD

WARNING!

Before starting this procedure, be sure the power is turned off at the breaker/fuse box.

Power Supply Cord

You will need a 4-wire power supply cord with four No. 10 copper wires and a matching 4-wire receptacle of NEMA Type 14-30R, as illustrated below. The fourth wire must be identified with a green cover and the neutral conductor by a white cover.

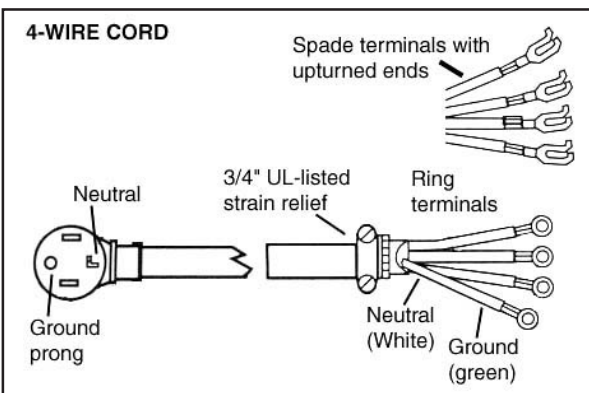

To connect a 3-wire power cord to the dryer, follow the steps below.

NOTE: The numbers in the illustration below correlate to the step numbers.

1. Turn the power off at the breaker/fuse box.
2. Remove terminal block cover.
3. Use the strain relief attached below the terminal block opening.
4. Remove center terminal block screw.
5. Remove ground wire (green with yellow stripes) from external ground connector screw. Fasten under center, silver-colored terminal block screw.
6. Connect ground (green) wire of cord to external ground conductor screw.
7. Connect neutral (white) wire of cord under center screw of terminal block.
8. Connect the other wires to outer screws.
9. Tighten the strain relief screws.
10. Replace terminal box cover on back of dryer.
11. Plug dryer into wall receptacle.
12. Turn power on at breaker/fuse box.

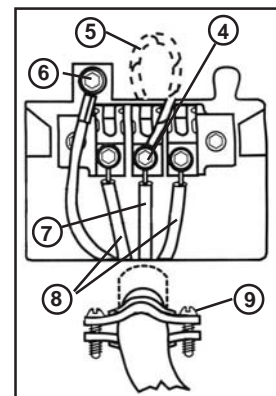

STACKED INSTALLATION

ASKO dryers can be mounted on top of any matching ASKO washer. Mounts are supplied with the machine. The metal brackets are attached to the lower back of the unit. The plastic cups are packed inside the dryer.

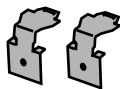

Two metal brackets for securing the dryer to the washer



Two plastic cups to secure the dryer legs.

To install the dryer on top of the washer, follow the steps below:

1. Remove the two outside screws (A) (20 torx) from the back of the washer and use them to secure the metal brackets (B), as illustrated below.

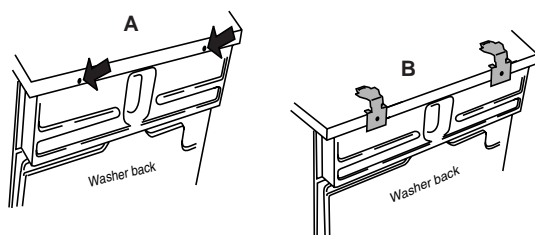

2. To ensure the dryer is correctly positioned on top of the washer, you will need to align the plastic cups with the front top edge of the washer. To position the plastic cups, break off the left tab on the cup to be placed on the right side of the washer and break off the right tab on the cup to be placed on the left side of the washer.

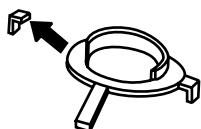

Plastic cups

3. Remove the protective paper from the self-adhesive surface beneath the cups. Being careful not to press the adhesive surface against the top of the washing machine, use the tabs to position the cups (as illustrated below) then press them firmly into place.

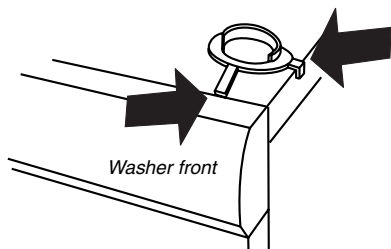

4. Once the cups are correctly in place, break off the remaining plastic tabs.

5. Lift the dryer into position. Raising the front edge, push the dryer backwards until it engages with the brackets on the back of the washer.

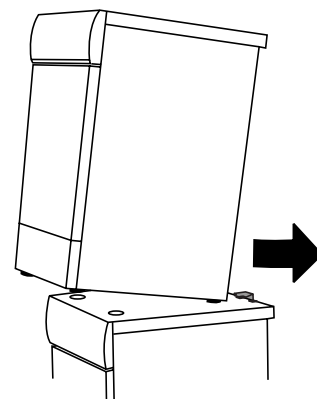

6. Carefully lower the front of the dryer, making sure the feet fit into the plastic cups.

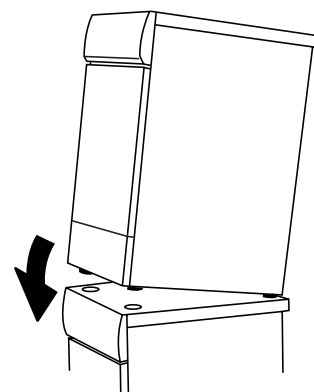

Stacked Installation

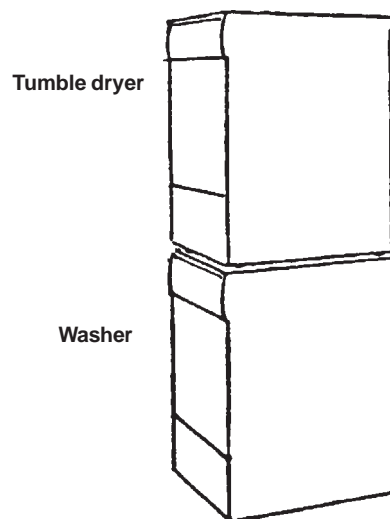

Tumble dryer

Washer

Total height 67".
Adjustable to 69".

WARNING!
Never stack a washer on top of a dryer!

REVERSING THE DOOR HINGES

The door hinges on ASKO dryers are reversible. The dryers are shipped left-hinged. To reverse them, follow the steps below:

WARNING! Switch off the main power supply before you start this procedure.

1. Remove the two 20 torx screws on the bottom of the bottom panel then grasp the bottom of the panel and pull it forward and down.

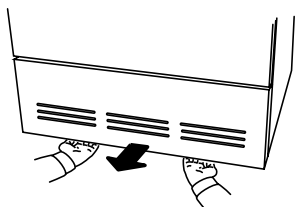

2. Remove the bottom hinge bracket by removing the three screws holding the bracket in place.

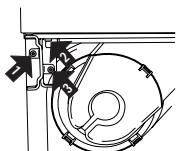

3. Supporting the door from the bottom, pull it out and to the left as you turn the hinge bracket counter-clockwise.

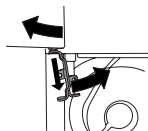

4. Remove the hinge pin at the top of the hinge bracket.
5. Turn the hinge bracket upside down and put the hinge pin into the top hole.

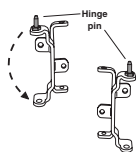

6. Transfer the top hinge pin to the right side of the dryer casing.

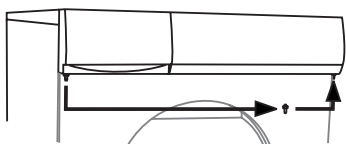

7. Loosen the two screws on both outer edges of the door so you can remove the magnetic door catch and the cover plate.

8. Remove the magnetic catch by pushing it up then lifting it out from the bottom.

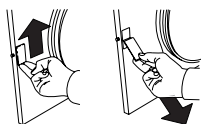

9. Remove the cover plate on the opposite side of the door by pushing it down then lifting it out from the top.

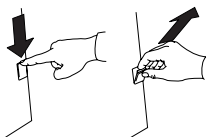

10. Reverse steps 8 and 9 to place the door catch and cover plate into their new positions.

11. Tighten the screws on the sides of the doors to hold the magnetic catch and cover plate in place.

12. Using a flathead screwdriver, carefully remove the plastic plugs in the upper and lower edge of the door and place them in the empty holes on the opposite side.

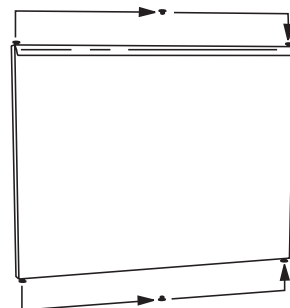

13. Remove the screw in the top right corner of the bottom panel. (If you have a condenser dryer, you will have to open the condenser unit door.)

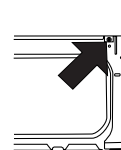

14. Now you are ready to mount the door on the right side. Holding the door at an angle (as illustrated), fit the hinge pin into the top hole.

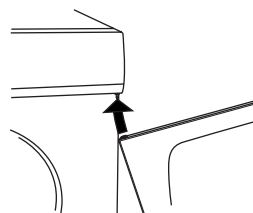

15. Position the bottom hinge bracket and secure it with the screws in the order illustrated at right (a, b, c).

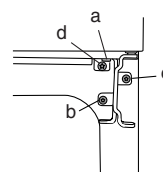

16. Replace the screw you removed in step 13 (d).

17. Replace the lower panel.

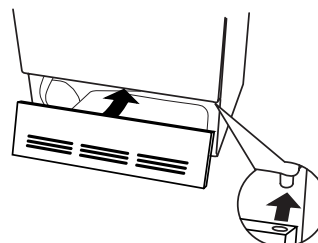

18. Turn back on the main power.

PREPARING THE LAUNDRY

With proper attention to how you prepare your laundry items for washing and drying, your wardrobe and linens will look like new for years.

SORTING THE LAUNDRY

For best drying results, clothes should be sorted properly. Most importantly, you should follow the care label instructions (see next page).

Below are some suggestions on how to sort your laundry for drying.

- ◆ Permanent press items should be dried together. For the most wrinkle-free results when drying permanent press items, you should fill the machine only half full. These items also should be removed promptly from the dryer and hung up or folded right away.
- ◆ Dry heavy fabrics together and lightweight fabrics together.
- ◆ Dry fabrics that *shed* lint (chenille, terry cloth, etc.) separately from fabrics that *collect* lint (synthetics, velveteen, corduroy, etc.).
- ◆ Separate non-colorfast fabrics from light-colored items.
- ◆ If the care label says "Wash Separately," the fabric is likely to lose color (excess dye) for the first few washings. To minimize the possibility of the dye transferring to white or lighter colored items, dry new colored garments with items of similar color or alone. Bright reds and oranges on cottons are the dyes most likely to transfer colors.

NOTE: Refer to "Important Safety Instructions" on page 2 for a list of specific materials that should never be put in a tumble dryer.

FABRIC SOFTENER SHEETS

We recommend that you do not use fabric softener sheets in the dryer. Over time, the chemicals on these sheets can build up inside the lint filter and clog the holes that circulate the air.

RECOMMENDED TEMPERATURE SETTINGS AND LOAD SIZES

Different fabrics require different load sizes and drying temperatures. The table below gives recommended

DRYING TIMES

Drying times will vary due to the amount of laundry in the machine, moisture content, type of fabric, air temperature and humidity.

GENERAL LAUNDRY ADVICE

- ◆ Read all recommended care labels carefully. If the care label says "Drip dry," "Line dry" or "Dry flat," do not dry that item in the dryer. Certain fabrics will melt or become dangerously flammable if heated, while others may lose their shape.
- ◆ Remove any sharp ornaments, pins or buckles to prevent snags.
- ◆ Empty pockets and turn them inside out.
- ◆ Close zippers and hooks to prevent snagging.
- ◆ Tie sashes and strings to prevent tangling.
- ◆ Mend any small rips to prevent them from enlarging.
- ◆ Turn colored cotton garments, velvet and finer knitwear inside out before washing.
- ◆ Turn delicate items, sweaters and T-shirts inside out to prevent pilling and to protect the prints.
- ◆ Prewash severely soiled items.
- ◆ Wash and dry colored fabrics separately the first time.
- ◆ Thoroughly rinse down items, such as comforters (Super rinse).
- ◆ Use fabric softener to eliminate static electricity in synthetic garments and to soften cotton.

temperature settings and load sizes for different fabrics.

| <i>Fabric Type</i> | <i>Temp Setting</i> | <i>Load Size</i> |
|---|---------------------|------------------|
| Cotton w/out elastic and/or decorative trim | Normal | Full |
| Linen – white and colorfast | Normal | Half |
| Cotton/polyester blends | Low | Half |
| Polyester/acrylic blends | Low | Half |
| Rayon and acetate | Low | Half |
| Washable silk and nylon * | Low | Third |

* Always refer to the care label on the garment to determine if it can be tumble dried. (See page 11.) Some wool and silk and hand-washable items should not be tumble dried. These items should be removed from the washer then pressed out in a terry towel to remove excess water before being hung up or laid flat to dry.

CARE LABEL INSTRUCTIONS





































Most clothes and other washable items have recommended care labels. *Read these labels carefully!* Care label instructions and warnings should be followed for the best cleaning results.

The table below defines the symbols used on fabric care labels. (NOTE: Some manufacturers may use slightly different symbols.)

As an example, the symbols in the label illustrated below mean: wash in warm water on permanent press setting. Use non-chlorine bleach. Dry on permanent press setting. Iron on low temperature setting.



CARE LABEL SYMBOLS

| | |
|--|--|
| <p>WASH CYCLE</p> <ul style="list-style-type: none">  Normal wash cycle  Permanent Press or Wrinkle Resistant setting  Gentle/Delicate setting  Hand wash only  Do not wash  Do not wring. Hang dry, drip dry, or dry flat <p>WASH WATER TEMPERATURE</p> <ul style="list-style-type: none">  Maximum water temp 200° F/95°C  Maximum water temp 160° F/70°C  Maximum water temp 140° F/60°C  Maximum water temp 120° F/50°C  Maximum water temp 105° F/40°C  Maximum water temp 85° F/30°C <p>BLEACH INSTRUCTIONS</p> <ul style="list-style-type: none">  Any bleach when needed  Only non-chlorine bleach  Do not bleach <p>DRY CLEAN SYMBOL</p> <ul style="list-style-type: none">  Dry clean only | <p>TUMBLE DRY CYCLE</p> <ul style="list-style-type: none">  Machine dry  Normal setting  Permanent Press or Wrinkle Resistant setting  Gentle or Delicate setting  Do not tumble dry <p>TUMBLE DRY HEAT SETTING</p> <ul style="list-style-type: none">  Any heat  High heat  Medium heat  Low heat  No heat/Air fluff <p>SPECIAL DRYING INSTRUCTIONS</p> <ul style="list-style-type: none">  Line dry or hang to dry  Drip dry (do not spin or wring)  Dry flat  Dry in shade <p>IRONING INSTRUCTIONS</p> <ul style="list-style-type: none">  Ironing is necessary  High temperature setting  Medium temperature setting  Low temperature setting  Do not iron or press with heat  Iron without steam |
|--|--|

T741C OPERATING INSTRUCTIONS

WARNING! To reduce the risk of electric shock or injury to persons, read the "Important Safety Instructions" section on page 2 before operating this appliance.

THE CONTROL PANEL

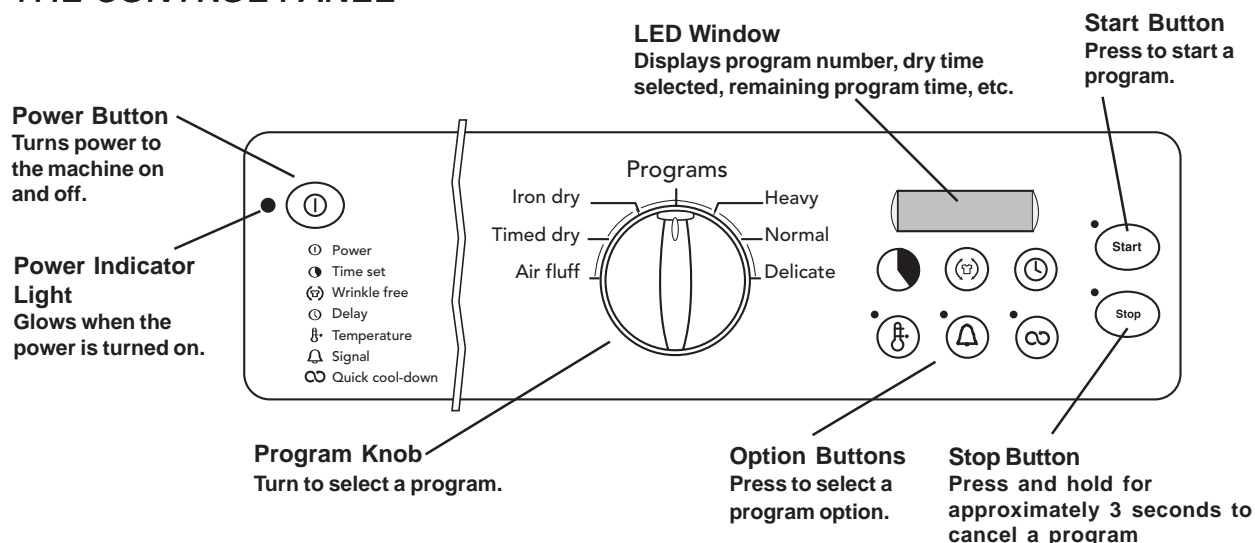

POWER BUTTON

The Power button turns the power to the machine on and off. When the power is on, the power indicator light glows red. The power must be on before you can start the machine.

PROGRAM KNOB

Turn this knob to select a program. The programs are described on the following page.

12:00 Position – This is where the line on the knob aligns with the line above the knob. When the knob is in this position, "00" displays on the LED to indicate no program has been chosen.

START BUTTON

After you have selected a program and the desired options, press this button to start the dryer. The red indicator light next to the Start button will come on. The indicator light will go off when the program ends or has been cancelled.

STOP BUTTON

You can stop or cancel a program by pressing and holding the Stop button until the dryer stops. When you press Start, the program will start from the beginning.

INTERRUPTING OR CANCELLING A PROGRAM

To interrupt a program, simply open the door. The dryer will stop tumbling automatically. To continue the program, close the door and press Start. The program will continue from the point it was interrupted.

To cancel a program, press and hold the Stop button

until the Stop indicator light goes off (approximately 3 seconds). You will have to reselect a program and press Start to restart the dryer.

LED WINDOW

The LED window displays the program number for the Sensidry programs, as illustrated below:



The corresponding program numbers are:

Heavy = P1 Delicate = P3
Normal = P2 Iron Dry = P4

When you select Timed Dry, the LED displays the number of minutes selected, *plus* the cool-down time, as illustrated below:



When you select Air Fluff, the LED displays the number of minutes selected, as illustrated above. With both programs, Timed dry and Air fluff, as the program advances, the LED displays the remaining time.

"End" on the LED indicates the program is complete.

"C" indicates the program is in the cool-down cycle.

PROGRAMS

Your ASKO dryer has our state-of-the-art Sensidry system. This means it has a humidity sensor that ensures different fabrics always dry thoroughly. This sensor turns off the heat when the laundry has reached the appropriate dryness.

The Heavy, Normal, Delicate and Iron Dry programs are automatic (Sensidry) programs designed for certain types of loads, as defined in the table below. The sensor detects different levels of humidity with each program. It is important, therefore, to select the appropriate program for the type of load you are drying.

If you prefer, you can select Timed Dry, which does not

activate the humidity sensor. You should be careful when using this option not to overdry the fabrics. This program automatically uses the Low temperature setting, but you can change it to Normal by depressing the Temperature button.

When using Timed Dry, it's best to use a shorter time; then if the load isn't dry, you can set the timer for a few more minutes.

NOTE: Always follow the care label instruction.

| <i>Program</i> | <i>Definition</i> |
|----------------------|---|
| Heavy (P1) | For items that are extremely difficult to dry, such as jeans and thick towels. |
| Normal (P2) | Cotton w/out elastic and/or decorative trim. |
| Delicate (P3) | Cotton with elastic and/or decorative trim, linen (white and colorfast). |
| Iron dry (P4) | Synthetics, polyester, cotton/polyester blends. |
| Timed Dry | Any fabric that can be machine dried. (See note below.) |
| Air Fluff | This setting does not heat. It simply circulates the air as the clothes tumble to shake out the dust and refresh the clothes. (See note below.) |

NOTE: When using Timed Dry and Air Fluff, you must set the number of minutes for the program to run. (See "Time" in the "Option Buttons" section below for details.)

OPTION BUTTONS

The option buttons allow you to select program time, normal or low temperature, anti-crease, delayed start, buzzer and quick cooling. Each of these options is defined in more detail in the following paragraphs.

TIME SET

If you set the program knob to Timed Dry or Air Fluff, you must select the length of drying time by pressing this button until the number of minutes you wish to dry the load displays on the LED. The time advances in 5-minute increments and you can select between 5 and 90 minutes. If you pass the time you wanted to select, continue to press the button until the correct time displays.

WRINKLE-FREE

The Wrinkle-free option prevents garments from wrinkling if you're unable to remove them right away. You can select one, two, or three hours by pressing the Wrinkle-free button until the number of hours you prefer displays, as illustrated below:

 1h

NOTE: "0" on the LED indicates the option is not active.

When you set a time, the drum will continue to rotate after the program is complete for three seconds every minute until the door is opened or the selected time (1–3 hours) has passed. If the buzzer is on, it will sound each time the anti-crease program activates.

DELAY

This option lets you set the dryer to start at the most convenient time. This feature is also useful in areas where utility companies offer discount rates during off-peak hours. You can set delayed start from 1 hour to 24 hours, in one-hour increments.

To set a delayed start time, press the button until the number of hours you wish to delay starting the machine displays on the LED, as illustrated below:

 1h

If you pass the time you wanted to select, continue to press the button until the correct time displays. If you decide not to delay starting the unit, continue to press the button until "0" displays.

Press Start and the unit will start after the number of hours you selected has passed.

To cancel Delay Start after you have pressed the Start button, press and hold the Stop button until the LED displays either the program number or minutes if you were running a Timed dry or Air fluff program.

You can then press Start and the unit will start right then.

TEMPERATURE

You have two temperature options: Normal and Low. The Normal setting should be used for heavier fabrics, such as denim, cotton, linen, etc. The Low setting should be used for lighter, more delicate fabrics, such as synthetics, permanent press, acrylics, etc.

The indicator light will stay lit when Low is selected. It will remain off when Normal is selected.

SIGNAL

Press this button to set a signal to sound for three seconds when a program is complete. The indicator light will stay lit when this option is on.

If you selected the Wrinkle-free option, the signal will sound every time the drum rotates.

QUICK COOL-DOWN

Every program, except Air Fluff, ends with a cool-down cycle that tumbles the clothes without heat to reduce wrinkling. The Cool-down button lets you choose between the Normal cool-down cycle (15 minutes) or a Quick cool-down cycle (5 minutes). The indicator light will stay lit when Quick is selected.

CHANGING OPTION SETTINGS

You cannot change the option settings after you have pressed Start. To change a setting, hold down the Stop button until the unit stops, make your change, then press Start again. The program will restart from the beginning.

PROGRAM MEMORY

The dryer is designed to retain the settings last selected with each program. For example, if you select Normal, the Low temperature option, a 2-hour anti-crease, and Quick cool-down, next time you select Normal these options will automatically be selected.

CHILD-SAFE START FEATURE

You can program the dryer not to start unless the Start button is held down for three seconds. This is to prevent children from inadvertently starting the machine. To program this function, follow the steps below:

1. Turn the machine off then on again. ("00" should show on the LED.)
2. Press the Start button five times in succession then press the Wrinkle-free button five times. (This must be done within 15 seconds.)
3. Within three seconds, press the Wrinkle-free button again to select Child-safe start. The LED will display "3" to indicate the Child-safe start is active. (If the child-safe start has already been activated, "0" will display after you press the Wrinkle-free button.)

ERROR MESSAGES

Error messages will display on the LED if a fault occurs while a program is in progress. The table below defines each possible error message. If the message still

displays after you have checked the possible solutions, call a service technician.

| MESSAGE | ERROR |
|---------|---|
| F1 | Call a service technician. |
| F2 | There may have been a power outage. Check the breaker box and fuses. The dryer is programmed to stop after a maximum of 3 hours drying time. If it has run this long, let it cool and try to start the program again. Try turning the power off then on again. If the message remains, call a service technician. |
| F3 | This indicates a thermistor fault. Call a service technician. |
| F4 | This indicates the overheat protection device has activated. Clean the lint filter and try running the program again. |
| F5 | This indicates a fault in the moisture sensor. Running a dry program with dry clothes or an empty machine could also cause this error. Try opening the door. If the message remains, call a service technician. |

CARE AND MAINTENANCE INSTRUCTIONS

CLEANING THE LINT FILTER

The wear on fabrics in a tumble dryer is insignificant. The lint caught in the lint filter is dust and fiber residue that has been formed when the garments have been worn. The lint filter must be cleaned after *each* load. If this is not done, drying performance will suffer, as insufficient air will pass through the drum. The machine may also overheat after a while, which will cause it to stop automatically.

To clean the lint filter, follow the steps below:

1. Grasp the handle and pull it toward you.
2. Remove the filter from the holder.
3. Open the filter and gently brush away any lint.
4. Fold the filter together and return it to the holder on the door.
5. Push the holder in until it snaps into place.

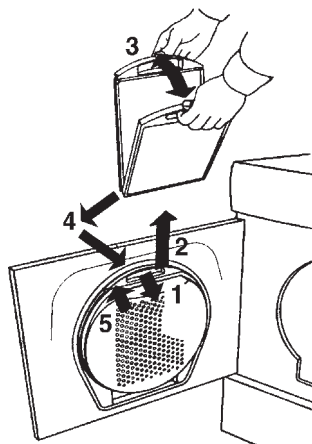

NOTE: If you use dryer sheets (not recommended), you may occasionally need to wash the lint filter with warm water and a soft brush to clean any blocked holes.

CLEANING THE CONTROL PANEL

To clean the control panel, use only a soft, warm, damp (not wet) cloth. To prevent penetration of water into the door lock and electrical components, **never spray water or cleaning solvent of any kind on the control panel.**

Also, never use abrasive cleaners or scouring pads on the outer surfaces because they will scratch the finish and possibly remove the writing on the control panels. Some paper towels may also scratch the finish.

CLEANING THE FAN

The fan should be cleaned at least once a year. If you have pets, you should clean it more often. To clean the fan, follow the steps below:

1. Turn off the main power to the machine.

2. Remove the two 20-torx screws on the bottom of the front panel then grasp the bottom of the panel and pull it forward and down.

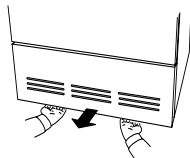

3. Unscrew the two 10-torx safety screws (A) on the bottom of the fan cover and fold out the four tabs (B).

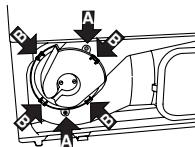

4. Remove the fan cover.

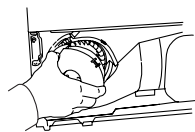

5. Hold the fan in place while you unscrew the nut.

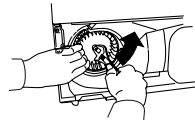

6. Pull out the fan and clean it with a brush and water.

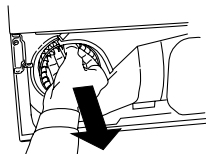

7. Replace the fan and screw the nut securely.

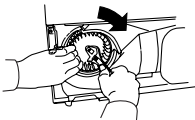

8. Replace the fan cover and fold the lugs back into place. Replace the safety screws.

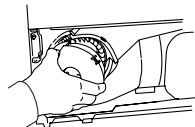

9. Replace the front panel.

10. Turn back on the main power.

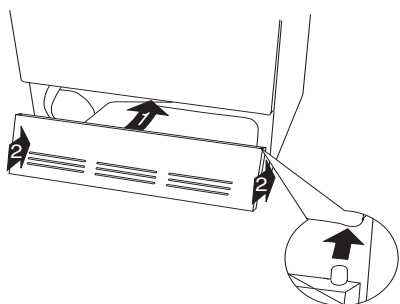

CLEANING THE CONDENSER

The condenser should be cleaned on a regular basis, preferably monthly. If you have pets, you should probably clean it more often. To clean the condenser, follow the steps below:

1. Turn off the main power to the machine.

2. Remove the two 20-torx screws on the bottom of the front panel then grasp the bottom of the panel and pull it forward and down.

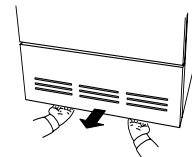

3. Turn the levers on the condenser cover counter-clockwise to release it then pull it down.

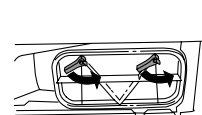

4. Pull out the condenser.

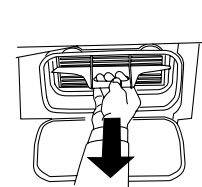

5. Spray the filter with warm water until all of the lint is removed.



WARNING!

Do not put the condenser into a dishwasher. Do not use any sharp metal objects or a wire brush to clean the condenser. Also, do not poke anything between the fins.

6. Make sure the side marked "UP" does face up and carefully replace the condenser into the unit.

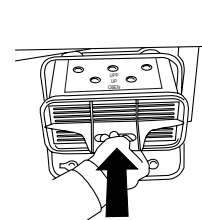

7. Close the condenser cover.

8. Replace the front panel.

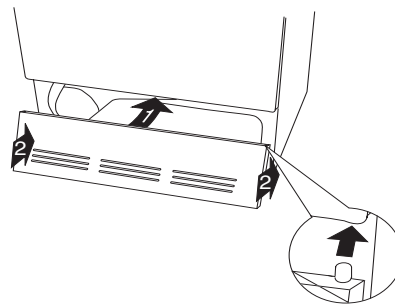

9. Turn back on the main power.

TROUBLESHOOTING

If you experience a problem with your dryer, you should review the following list of frequently encountered situations or go to our website at www.askousa.com. It could save you the cost and inconvenience of a service call.

Even though the product is under warranty, if the problem is not caused by defective product workmanship or materials, you will be charged for a service call. Refer to page 25 to determine what is and is not covered under your warranty. If you're still not sure, contact the AM Advisory Center before you call a serviceman.

BEFORE YOU CALL

Before calling for service or contacting ASKO regarding a warranty issue, make a note of the model name, type number and serial number. The model is on the left front of the control panel. The type plate with the type name and serial numbers is located behind the door in the upper left corner. (See illustration at right.)

Model Name

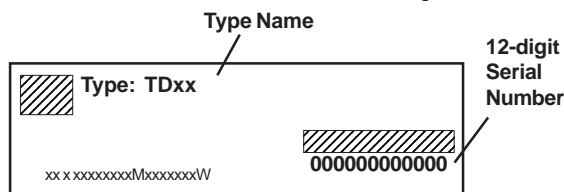
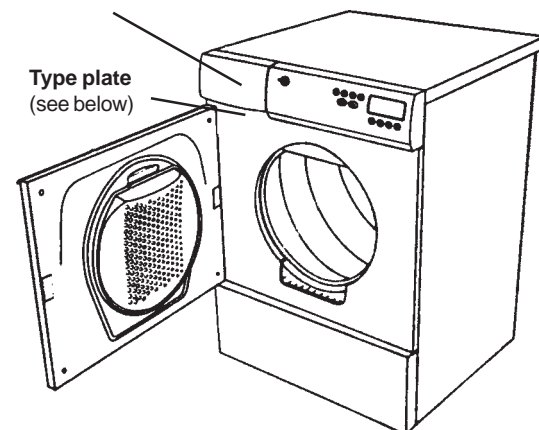

The machine won't start.

- ◆ Make sure the door is closed securely.
- ◆ Make sure the Power is turned on.
- ◆ Check that you set the program or time correctly.
- ◆ Check that the electric plug is securely in the socket.
- ◆ Check the house breaker/fuses.
- ◆ If all of the above options are eliminated, the overheat protection has probably been activated. See "Overheat Protection" on page 3 for possible causes and instructions on how to restart the unit.

The machine takes too long to dry my laundry.

- ◆ Check that the lint filter is clean.
- ◆ If you use dryer sheets (not recommended), you may need to wash the lint filter with warm water and a soft brush to clean any blocked holes.
- ◆ Be careful not to overload the dryer because the warm air needs sufficient room to circulate properly and the clothes need room to tumble freely.
- ◆ The laundry should only be damp when it comes out of the ASKO washer. If it seems too wet, try using a faster or longer spin cycle.
- ◆ Make sure the condenser is clean.

My clothes are coming out wrinkled.

- ◆ You should remove the clothes as soon as the dryer signals the end of the cycle. If you can't remove the clothes right away, use the Anti-crease option.

- ◆ Dry heavy fabrics together and light fabrics together.
- ◆ Dry only permanent press items together.
- ◆ Dry in smaller loads.
- ◆ Use slower spin speeds.
- ◆ Use fabric softener in the rinse program.
- ◆ You may be using the wrong wash temperature. Try using a lower wash temperature, especially for permanent press and delicate items.

The motor is running but the drum isn't turning.

- ◆ This usually means a belt is broken. Call a servicer.

The machine makes a funny noise.

- ◆ A slight rumbling may be heard when you first turn on the dryer. This is normal and it should only last a few seconds.

ASKO PRODUCT WARRANTY

MODEL T741C

Be sure to complete the Warranty Registration Card you received with your appliance and mail it to AM Appliance Group to validate your appliance warranty.

Cosmetic damage must be reported to your dealer within five days from the date of purchase. After unpacking the dryer, thoroughly check the unit for cosmetic damage.

FOR RESIDENTIAL INSTALLATIONS ONLY

| <i>LENGTH OF WARRANTY</i> | <i>AM APPLIANCE GROUP WILL PAY FOR:</i> |
|---|--|
| <i>Three-Year Full</i> From date of purchase. | ASKO replacement parts and/or repair labor to correct defect in materials or workmanship. Service must be provided by an authorized ASKO service agent. |
| <i>Fourth & Fifth Year Limited</i> Three year full plus fourth and fifth year limited from date of purchase. | ASKO replacement parts (labor cost not included) for any defective solid-state controls, timers, motors, or pumps. Service must be provided by an authorized ASKO service agent. |
| <i>Lifetime</i> | ASKO replacement parts (labor cost not included) of the stainless steel drum if it fails to hold water due to a manufacturing defect, such as rusting or cracking. Service must be provided by an authorized ASKO service agent. |

FOR NON-RESIDENTIAL INSTALLATIONS

| | |
|--|---|
| <i>Six-Month Full Warranty</i> From date of purchase. | ASKO replacement parts and/or repair labor to correct defect in materials or workmanship. Service must be provided by an authorized ASKO service agent. |
|--|---|

AM APPLIANCE GROUP WILL NOT PAY FOR:

- A. Service calls to:
 - 1. Correct the installation of the appliance.
 - 2. Repair damage due to shipment, delivery, installation, misuse or abuse.
 - 3. Instruct how to use the appliance.
 - 4. Replace house fuses or correct house wiring.
 - 5. Correct house plumbing, including drainage problems related to improper installation.
 - 6. Clean or service air device in drain line.
- B. Repair and/or replacement parts for failure of product if appliance is used for other than home/residential use.
- C. Damage resulting from accident, fire, floods, acts of God, alteration, misuse, abuse, improper installation, or installation not in accordance with local electrical or plumbing codes.
- D. Any shipping costs for parts during the limited warranty period.
- E. Replacement parts or repair labor costs for units operated outside the Continental United States.
- F. Pickup and delivery. ASKO washers are designed to be repaired in the home.

IN NO EVENT SHALL AM APPLIANCE GROUP BE RESPONSIBLE FOR ANY INCIDENTAL OR CONSEQUENTIAL DAMAGES.

Some states will not allow the exclusion or limitation of incidental or consequential damages, so this exclusion or limitation may not apply to you. This warranty gives you specific legal rights and you may also have other rights which vary from state to state.

For warranty service, contact the dealer from whom you purchased the unit or an authorized ASKO service agent. Service will be provided during normal business hours. Should you have a service problem that can not be resolved locally, contact AM Appliance Group at the numbers listed below. Before calling for service or contacting AM Appliance Group regarding a warranty issue, make a note of the model, type name, and serial number (see page 24).

Write to us at:
AM Appliance Group
P. O. Box 851805
Richardson, Texas 75085-1805
www.askousa.com

Or call our
ASKO Advisory Center a
Division of AM Appliance Group at
800-898-1879 or
972-238-0794

INDEX

| | | | |
|----------------------------------|------|----------------------|----|
| A | | Sorting the laundry | 9 |
| Air Fluff program | 12 | Specifications | 4 |
| Anti-crease option | 12 | T | |
| Automatic door switch | 2 | Temperature settings | 9 |
| B | | Troubleshooting | 16 |
| Built-in installation | 5 | W | |
| Buzzer option | 13 | Warranty information | 17 |
| C | | | |
| Care and cleaning | 14 | | |
| Care label symbols | 10 | | |
| Child-safe start | 2 | | |
| Condensation drain connection | 4 | | |
| Condenser, cleaning | | | |
| Control panel, cleaning | 15 | | |
| Cool-down | 3 | | |
| D | | | |
| Delayed start | 12 | | |
| Door hinges, reversing | 8 | | |
| Drying problems | 16 | | |
| Drying times | 9 | | |
| E | | | |
| Electrical connections | 5, 6 | | |
| Energy saving tips | 3 | | |
| Error messages | 13 | | |
| F | | | |
| Fabric softener sheets | 9 | | |
| Fan, cleaning | 15 | | |
| Freestanding installation | 5 | | |
| H | | | |
| Hinges, reversing | 8 | | |
| I | | | |
| Installation instructions | 4–8 | | |
| L | | | |
| Laundry tips | 9 | | |
| LED window | 11 | | |
| Lint filter | 14 | | |
| Load sizes, recommended | 9 | | |
| M | | | |
| Magnetic door lock | 2 | | |
| O | | | |
| Operating instructions | 11 | | |
| Overheat protection | 2 | | |
| P | | | |
| Power cord connection | 6 | | |
| Problem-solving | 16 | | |
| Programs and program options | 12 | | |
| R | | | |
| Remaining time indication | 11 | | |
| S | | | |
| Safety features and instructions | 2 | | |
| Sensidry | 3 | | |
| Service | 17 | | |
| Solutions to problems | 16 | | |

